



P.O. Box 247, 4320 Aerotech Center Way
Paso Robles, CA 93447
Telephone: (800) 350-2223 Fax: (805) 238-4201
PAGE 1 OF 3 Page Rev. Date: 02-05-18
P/N: 50-0225

DODGE NV4500 5 SPEED 23 SPL OUTPUT TO TOYOTA L/C 10 SPLINE

KIT CONSISTS OF:

No.	Qty	Part No.	Description
1.	1	51-0224	ADAPTER CASTING
2.	1	52-0225	10 SPLINE SPUD SHAFT (23T INTERNAL)
3.	1	716199	RETAINER
4.	1	716301	SEALED BEARING
5.	1	716507	GASKET
6.	8	720046	10mm-1.5 x 40mm S.H.C.S.
7.	2	723735	3/8" FLAT WASHER
8.	2	723739	3/8"-16 x 7/8" H.H.C.S.
9.	5	724303	7/16" LOCKWASHERS
10.	8	724324	7/16" HIGH COLLAR LOCK WASHER
11.	3	724345	7/16"-14 x 5" HEX HD BOLT
12.	2	724349	7/16"-14 x 1-1/2" H.H.C.S.
13.	1	728701	NYLON NUT
14.	1	728702	7/8" FLATWASHER

CAUTION:

There are two 3/8" holes located on the side of the adapter for the mechanical shifter linkage. If your vehicle has a 3 speed vacuum type shifter, these holes are not going to be used. They will need to be plugged with the hardware provided and small amount of silicone. P/N715532 can be ordered if you have a mechcal linkage.

SPECIAL NOTE: The components packaged in this kit have been assembled and machined for specific type of conversions. Modifications to any of the components will void any possible warranty or return privileges. If you do not fully understand modifications or changes that will be required to complete your conversion, we strongly recommend that you contact our sales department for more information. This instruction sheet is only to be used for the assembly of Advance Adapter components. We recommend that a service manual pertaining to your vehicle be obtained for specific torque values, wiring diagrams and other related equipment. These manuals are normally available at automotive dealerships and parts stores.



P.O. Box 247, 4320 Aerotech Center Way
Paso Robles, CA 93447
Telephone: (800) 350-2223 Fax: (805) 238-4201
PAGE 2 OF 3 Page Rev. Date: 02-05-18
P/N: 50-0225

DODGE NV4500 5 SPEED 23 SPL OUTPUT TO TOYOTA L/C 10 SPLINE

NOTE:

1. This adapter is designed for exclusive use of the Dodge 4WD 23 spline output version of the NV Model 4500 transmission. You must use this transmission due to the length and spline size of the output shaft. The shaft must be shortened to the 5.420" cutoff length (see Page 3). In order to cut the shaft off, you will need to remove the tailhousing. The shaft can be cutoff using an abrasive cutoff saw or a skill saw equipped with a special metal cutting blade. Be sure to use safety glasses during this procedure.
2. The assembly of the adapter plate to the transfer case should be very much like the original transmission that is being replaced. A new flat washer and nut are provided for the early model vehicles to hold the two gears in position.
3. The alignment between the new adapter plate and transfer case must be performed by the new bearing that has been included with the adapter. This bearing will have the external snap ring on the outside of the adapter similar to the original transmission. **When installing the adapter to the NV4500 make sure the stock dowel pins are in the transmission.**
4. When using this transmission assembly with a 6 cylinder Toyota engine, you may need to modify the gas tank area on 1979 and newer vehicles. It would be advisable that your vehicle be equipped with a suspension lift and you should plan on removal of the stock rear crossmember. A new Advance Adapter crossmember #716022-TSW, will be required. This transmission assembly is the very shortest possible and careful planning is a must when performing the installation with the stock 6 cylinder.
5. The transfer case shift controls will need to be modified for use with the new transmission.

SPECIAL NOTE: The components packaged in this kit have been assembled and machined for specific type of conversions. Modifications to any of the components will void any possible warranty or return privileges. If you do not fully understand modifications or changes that will be required to complete your conversion, we strongly recommend that you contact our sales department for more information. This instruction sheet is only to be used for the assembly of Advance Adapter components. We recommend that a service manual pertaining to your vehicle be obtained for specific torque values, wiring diagrams and other related equipment. These manuals are normally available at automotive dealerships and parts stores.

DODGE NV4500 5 SPEED 23 SPL OUTPUT TO TOYOTA L/C 10 SPLINE

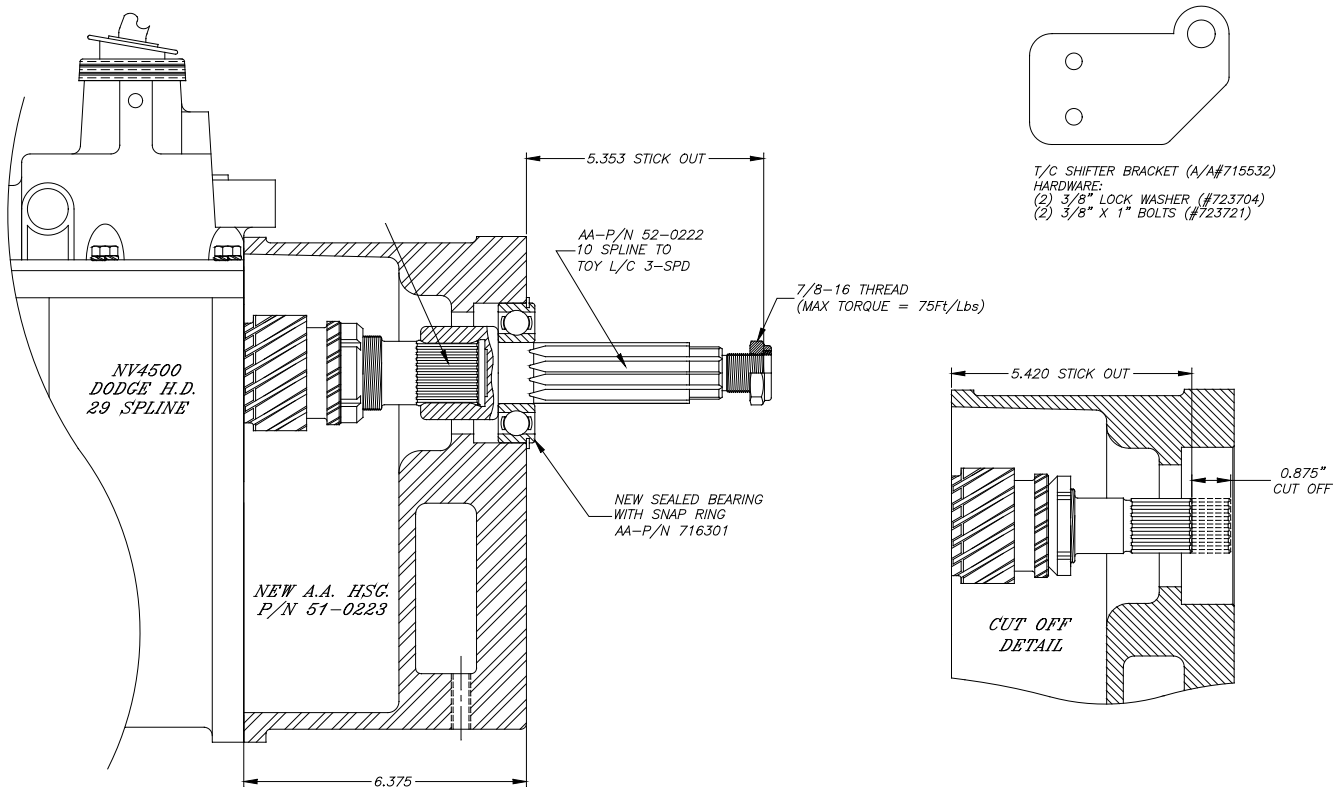

SPECIAL NOTE: The components packaged in this kit have been assembled and machined for specific type of conversions. Modifications to any of the components will void any possible warranty or return privileges. If you do not fully understand modifications or changes that will be required to complete your conversion, we strongly recommend that you contact our sales department for more information. This instruction sheet is only to be used for the assembly of Advance Adapter components. We recommend that a service manual pertaining to your vehicle be obtained for specific torque values, wiring diagrams and other related equipment. These manuals are normally available at automotive dealerships and parts stores.