

## GM 4L60E HEX AUTO OVERDRIVE TO LAND CRUISERS 1974-80 FJ40 (4 SPEED)

### KIT CONSISTS OF:

No.	Qty	Part No.	Description
1.	1	51-8900	CASTING ( <i>with sensor drilled</i> ) (Ref: 51-8900)
2.	1	51-0405	4L60E ADAPTER
3.	1	52-1600	SPUD SHAFT WITH 16 SPLINES
4.	1	300619	SENSOR
5.	1	715547	TRANSFER CASE SHIFTER BRKT.
6.	2	716079	22MM PLUG
7.	1	716301	BEARING
8.	1	*716345	BEARING SLEEVE FOR CASTING ( <i>INSTALLED BY AA</i> )
9.	1	716507	GASKET
10.	1	716511	"O"-RING
11.	3	723731	3/8"-16 x 1" S.H.C.S
12.	4	720011	NUT 10mm-1.5 (SQ. PATTERN ON 51-0405 CASTING)
13.	4	720015	10mm FLAT WASHER (SQ. PATTERN ON 51-0405 CASTING)
14.	2	720063	12mm-1.75 x 40mm H.H.C.S.
15.	5	720085	12mm LOCK WASHER
16.	3	720089	12mm-1.75 x 130mm H.H.C.S.
17.	4	720093	10mm-1.5 x 50 mm set screw (SQ. PATTERN ON 51-0405 CASTING)
18.	1	728701	NYLON LOCK NUT 7/8"-16
19.	1	728702	7/8" FLATWASHER

When using this adapter kit with an Orion transfer case, you will require two additional bolts for clearance on the new transfer case. 720098 is modified to clear the low gear and 720099 is a SHCS for clearance on the Orion case.

1.	1	720098	12mm X 1.75TH X 130mm H.H.C.S.- Orion Case (replaces one of the 720089)
2.	1	720099	12mm X 1.75TH X 30mm S.H.C.S.- Orion Case (replaces one of the 720063)

**NOTE: THIS KIT USES A 2WD 4L60E OUTPUT SHAFT (O.A.L. 18-3/16").**



NOTE: This kit requires the 2WD output shaft to be shortened. Please note that the cut off location on the output shaft must be made after the 51-0405 adapter is installed on the transmission. This 51-0405 adapter make the hex pattern 4L60E transmission look just like the square bolt pattern transmission, and the cut off location for the output shaft is shown on this instruction sheet is for the square bolt pattern transmission.

**SPECIAL NOTE:** The components packaged in this kit have been assembled and machined for specific type of conversions. Modifications to any of the components will void any possible warranty or return privileges. If you do not fully understand modifications or changes that will be required to complete your conversion, we strongly recommend that you contact our sales department for more information. This instruction sheet is only to be used for the assembly of Advance Adapter components. We recommend that a service manual pertaining to your vehicle be obtained for specific torque values, wiring diagrams and other related equipment. These manuals are normally available at automotive dealerships and parts stores.



P.O. Box 247, 4320 Aerotech Center Way  
Paso Robles, CA 93447  
Telephone: (800) 350-2223 Fax: (805) 238-4201  
PAGE 2 OF 4 Page Rev. Date: 09/27/19  
P/N: 50-0407A

## GM 4L60E HEX AUTO OVERDRIVE TO LAND CRUISERS 1974-80 FJ40 (4 SPEED)

### INSTALLATION INSTRUCTIONS

This kit is for the GM 4L60E 4 speed automatics to all Toyota Land Cruiser 4 speed transfer case. The design of this kit utilizes two shafts. The first shaft is your 4L60E output shaft that is cutoff to the length illustrated on page 3. With the shaft cut to the proper length, the new Advance Adapter spud shaft can now be put into position. The new spud shaft should be pressed into the new rear bearing so the external snap ring is towards the threaded end of the shaft. With the bearing on the spud shaft, you can now install the assembly into the back portion of the adapter. The external snap ring will lock the spud shaft into position. The threaded portion on the end of the spud shaft will be identical to the 4 speed transmission being replaced. The original gears, bearing, washer and nut will all be reused onto the new spud shaft. On the right side of the adapter, you will be able to mount the special shift bracket illustrated on page 4. This bracket should position your shifter in the original floor board location. Use the stock metric bolts to bolt the transfer case to the adapter housing.

### **GM 4L60E 4 SPEED AUTOMATIC:**

When installing the new transfer case adapter, make sure that the coupler and the output shaft do not bottom out. We have found on occasion that a transmission output shaft may be slightly longer than we have allowed for and when coupling into our new spud shaft, we find a small amount of interference. The adapter housing and spud shaft must be assembled to the back of the transmission without interference. **DO NOT FORCE THE NEW TAILHOUSING ONTO THE TRANSMISSION.** If assistance is needed, please feel free to call us toll free number at 1-800-350-2223.

When assembling the adapter housing to the transmission case, we have provided you with a new square type "O"-ring seal to prevent fluid leakage. This seal is a stock GM item that is used on all 4L60 installations. On most installations, a slight pan modification may be required for clearance of the front Universal yoke.

The Advance Adapter casting has been drilled for your new sensor. The sensor should be installed and the gap between the sensor and the ring should be .010" to .012" air gap.

**CAUTION:** Advance Adapters has designed this kit to use the stock seal in the transfer case as a barrier between the 4L60 and the Toyota Land Cruiser transfer case gear boxes. You should inspect your stock seal and replace if necessary before installing this adapter kit. This kit also uses a sealed bearing to aid in the isolation of fluids.

**NOTE:** Periodically check both your 4L60 fluid level and your transfer case fluid level for fluid contamination. If fluid contamination occurs, you should switch to ATF in your transfer case.

SPECIAL NOTE: The components packaged in this kit have been assembled and machined for specific type of conversions. Modifications to any of the components will void any possible warranty or return privileges. If you do not fully understand modifications or changes that will be required to complete your conversion, we strongly recommend that you contact our sales department for more information. This instruction sheet is only to be used for the assembly of Advance Adapter components. We recommend that a service manual pertaining to your vehicle be obtained for specific torque values, wiring diagrams and other related equipment. These manuals are normally available at automotive dealerships and parts stores.

## GM 4L60E HEX AUTO OVERDRIVE TO LAND CRUISERS 1974-80 FJ40 (4 SPEED)

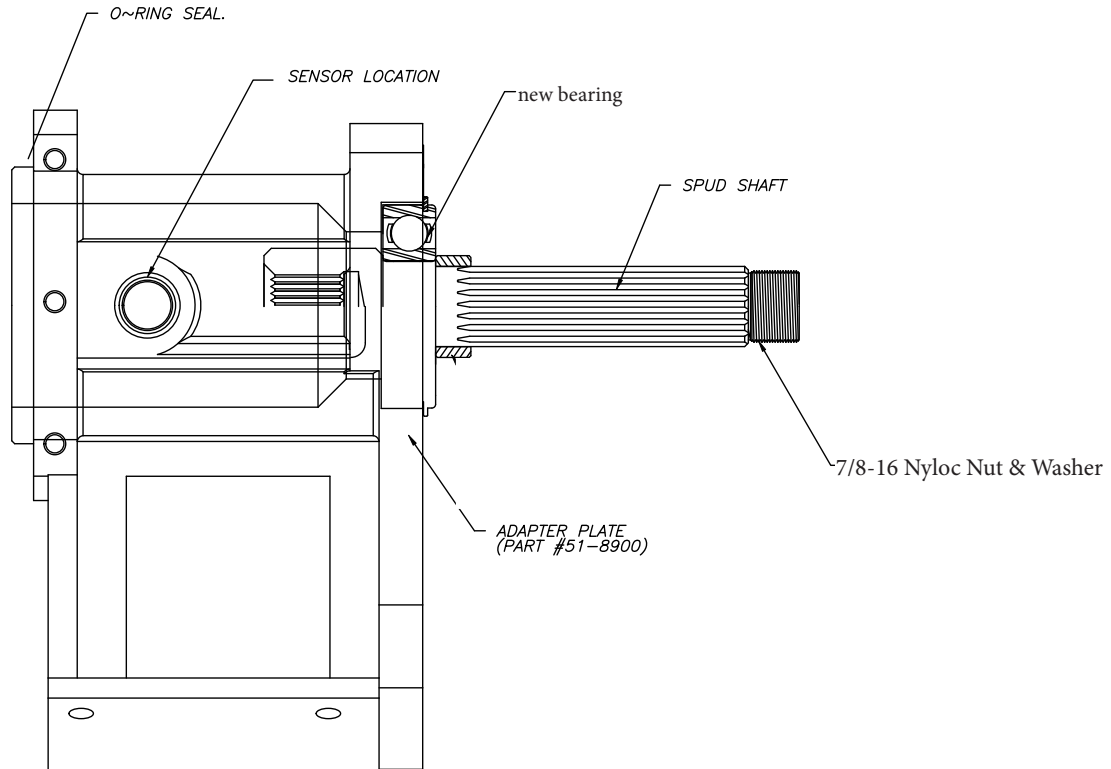
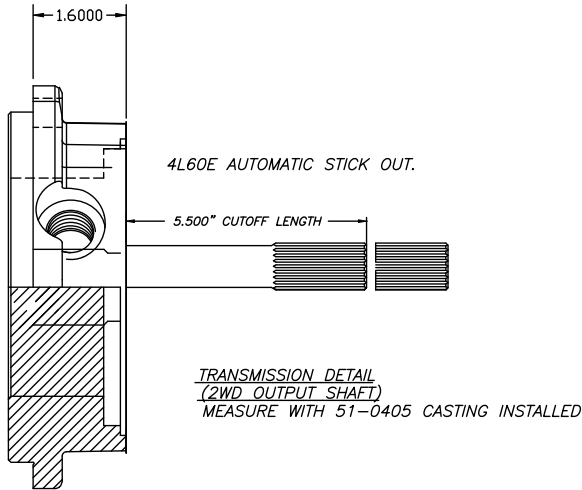

**SPECIAL NOTE:** The components packaged in this kit have been assembled and machined for specific type of conversions. Modifications to any of the components will void any possible warranty or return privileges. If you do not fully understand modifications or changes that will be required to complete your conversion, we strongly recommend that you contact our sales department for more information. This instruction sheet is only to be used for the assembly of Advance Adapter components. We recommend that a service manual pertaining to your vehicle be obtained for specific torque values, wiring diagrams and other related equipment. These manuals are normally available at automotive dealerships and parts stores.

## GM 4L60E HEX AUTO OVERDRIVE TO LAND CRUISERS 1974-80 FJ40 (4 SPEED)

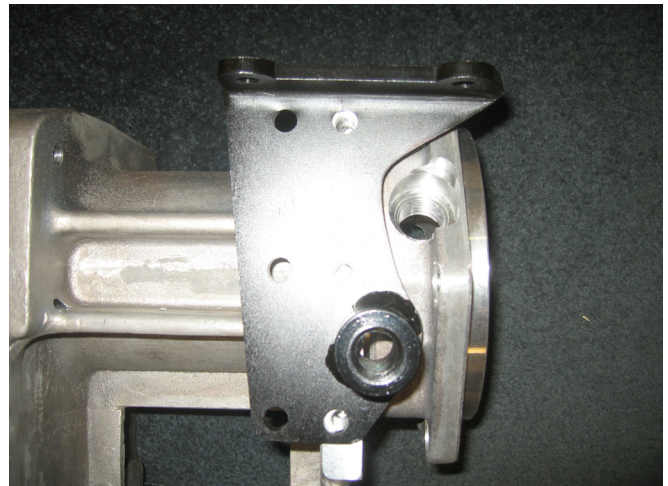

*the transfer case shifter bracket will require some modifications to clear the hex pattern of the 4L60E*

**SPECIAL NOTE:** The components packaged in this kit have been assembled and machined for specific type of conversions. Modifications to any of the components will void any possible warranty or return privileges. If you do not fully understand modifications or changes that will be required to complete your conversion, we strongly recommend that you contact our sales department for more information. This instruction sheet is only to be used for the assembly of Advance Adapter components. We recommend that a service manual pertaining to your vehicle be obtained for specific torque values, wiring diagrams and other related equipment. These manuals are normally available at automotive dealerships and parts stores.